



Metal Sheds

Technical Bulletin TB003

Foundation Guidelines

• Concrete • Paving Slabs • Decking

Please read this document carefully
prior to arranging an installation

Contents

1.	Pre-installation	3
2.	Ground Anchoring Kit	4
3.	Ground Fixing Methods	5
4.	Metal Storage Footprint and Dimensions	6
5.	Metal Shed Footprint and Dimensions	7

IMPORTANT: Keep this bulletin for future reference.

1. Pre-installation

IMPORTANT: Before considering any groundwork, it is advisable to choose the size and location of the shed you are going to be installing. Footprint and overall product dimensions are provided within this document to enable you to understand the minimum requirements for a base. We also recommend leaving an additional 50cm, obstruction-free, around the perimeter of your shed to allow for ladder access during installation.

NOTE: If you are planning to construct a new foundation for your shed, we recommend a concrete base. The base should be constructed solid and flat, without any uneven bumps in the surface, which could impede the overall stability of the product and cause misalignment issues whilst operating the doors. Should you wish to include a gentle gradient in your base to allow rainwater to drain away naturally, we recommend a fall of no greater than 20mm in either direction.

If you already have a base, we recommend that it meets the minimum size requirements stated in this document and that the surface is in a good state of repair. Should any sections of the existing base be uneven or damaged, localised repair work should be undertaken before arranging shed installation.

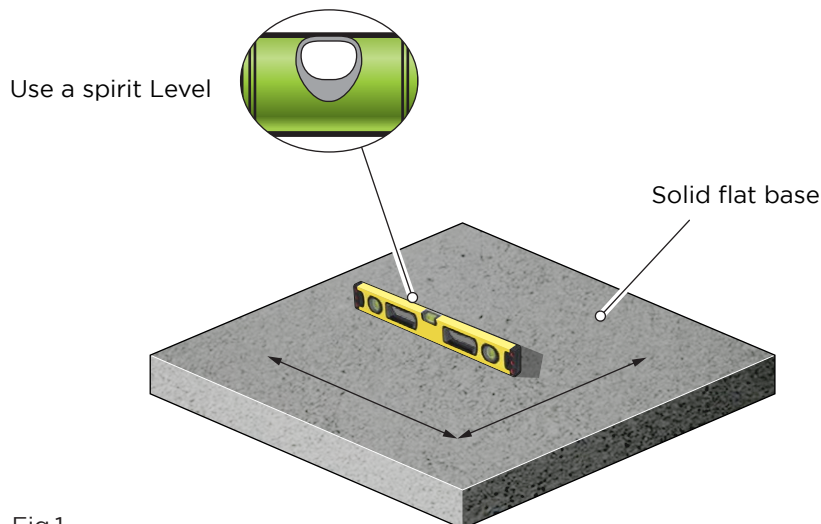
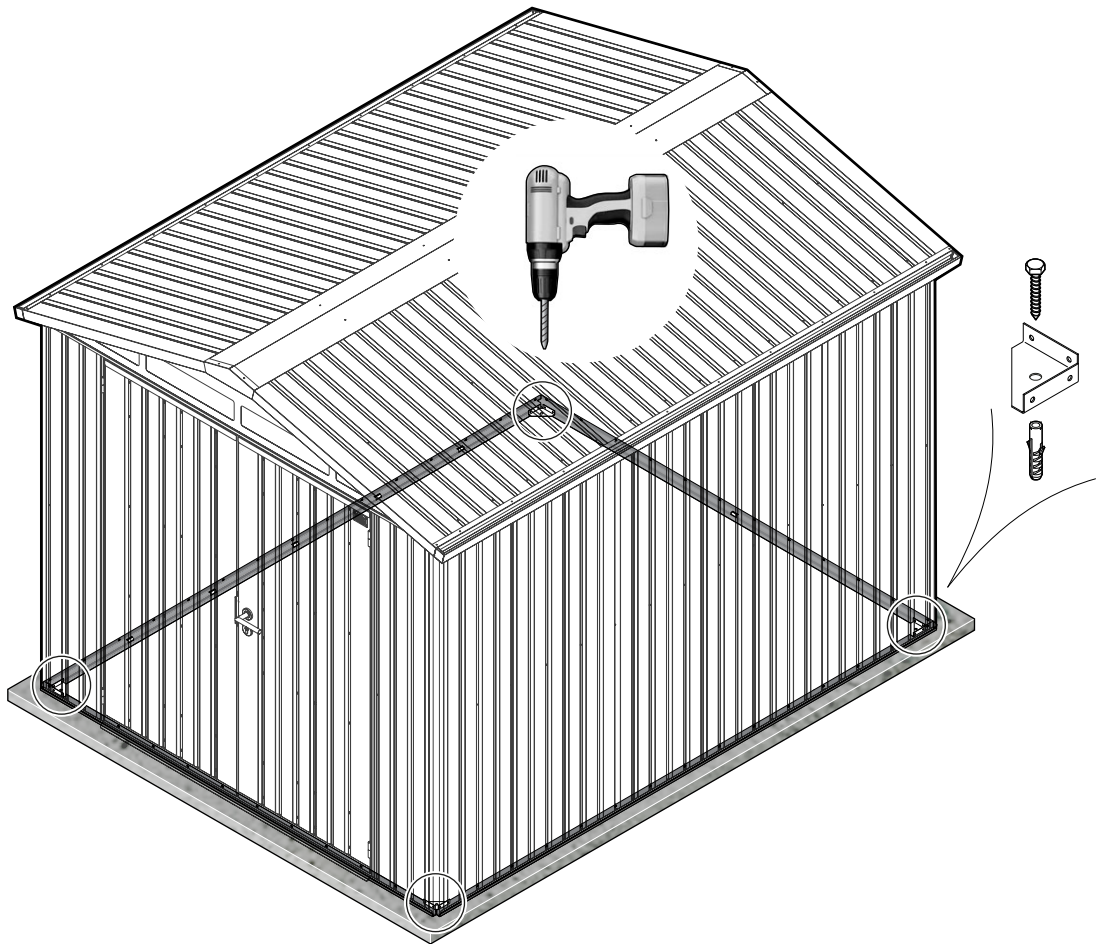

Fig.1

If you have any further questions, please call our customer service on: +44 (0) 1889 272 056

2. Ground Anchoring Kit

Each metal shed comes supplied with a ground anchoring kit. This includes a minimum of 4 x 50mm coach screws and expansion plugs. The quantity may vary depending on the size of the shed.



3. Ground Fixing Methods

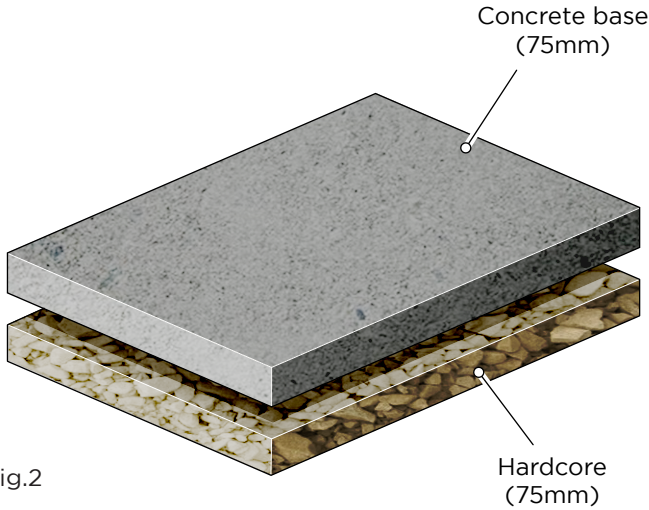

Fig.2

Concrete Base

If you have any doubt about the surface your metal shed will sit on. We recommend installing a concrete base for stability.

Typical Construction 75mm hardcore sub-base, finished with 75mm of concrete.

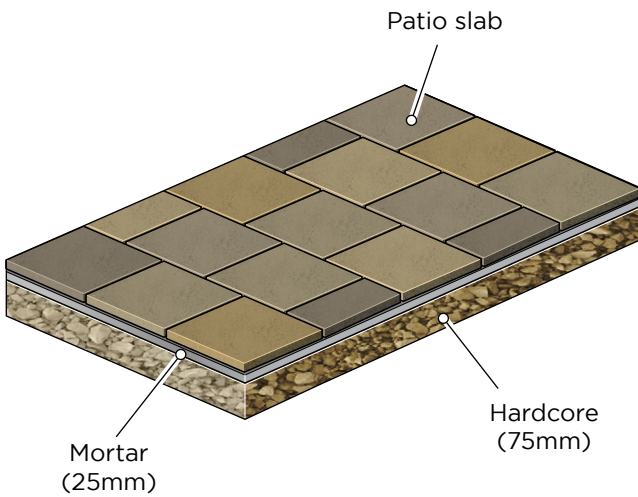

Fig.3

Patio Slabs or Block Paving

Paving slabs are an excellent alternative to a concrete base. Each slab should be laid to form a continuous level base.

Typical Construction 75mm hardcore sub-base, with 25mm of mortar under the patio slabs.

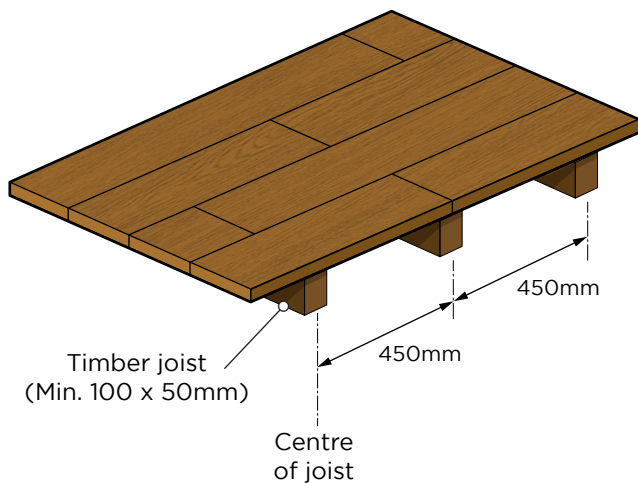

Fig.4

Decking

You can install a metal shed onto decking, but due to the natural movement in the timber, we recommend a concrete base or patio slab as a more permanent solution.

Typical Construction 100mm x 50mm joists with equal spaces.

4. Metal Storage Footprint and Dimensions

Footprint

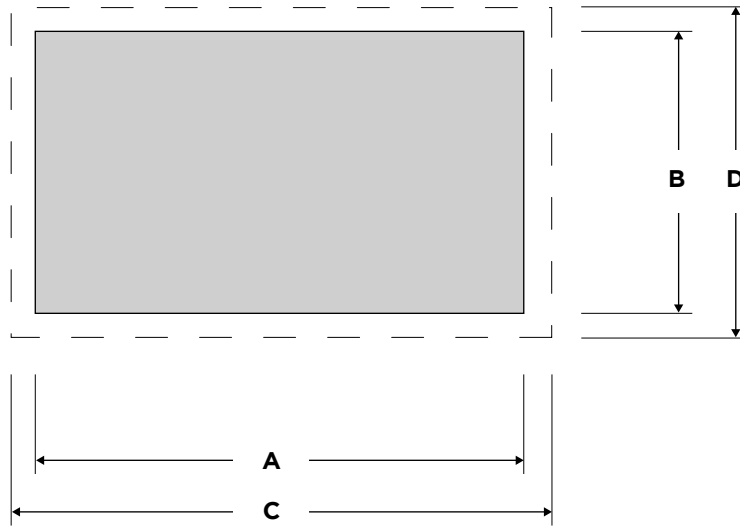

	Footprint		Base (min.)	
	A	B	C	D
Weston	1.4m	0.8m	1.5m	0.9m
Bromley	1.9m	0.9m	2.0m	1.0m

Weston Vertical Storage

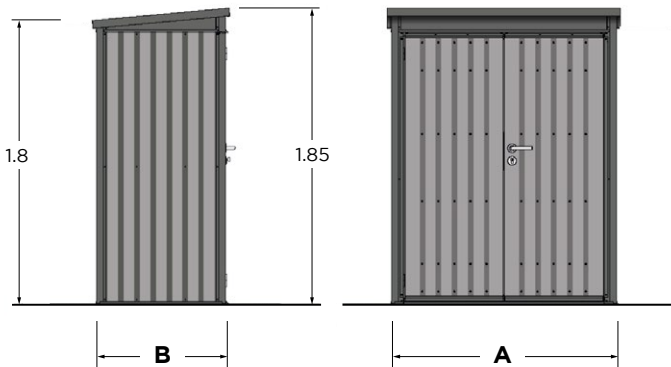

Bromley Horizontal Storage

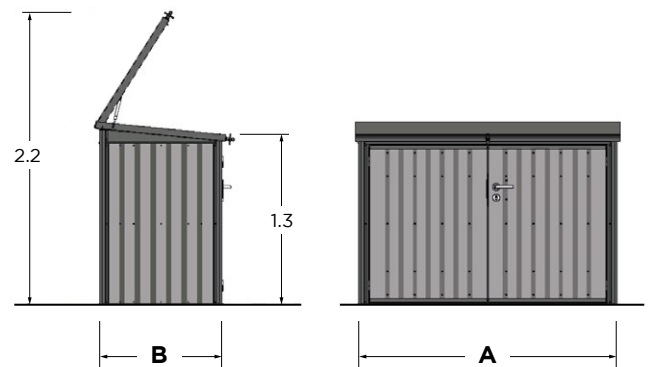

Overall Storage External Dimensions (m)

5. Metal Shed Footprint and Dimensions

Footprint

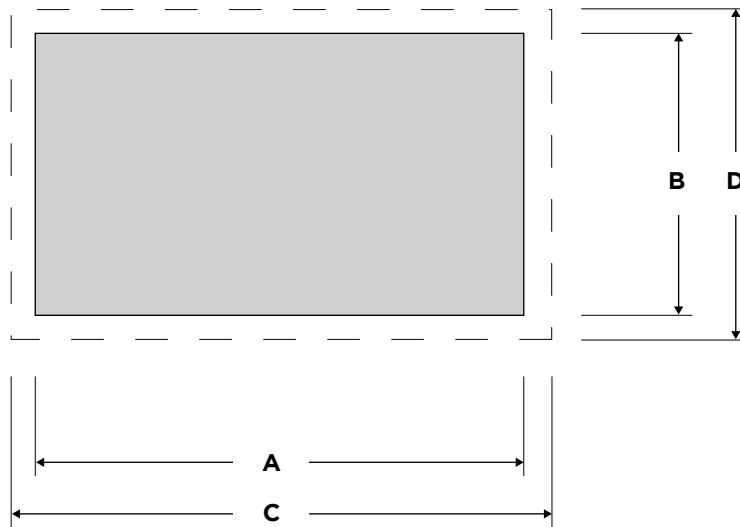

	Footprint		Base (min.)	
	A	B	C	D
6 x 6	1.7m	1.7m	1.8m	1.8m
8 x 6	2.3m	1.7m	2.4m	1.8m
8 x 8	2.3m	2.3m	2.4m	2.4m
10 x 6	2.9m	1.7m	3.0m	1.8m
10 x 8	2.9m	2.3m	3.0m	2.4m

Alton Metal Shed

Hixon Metal Shed

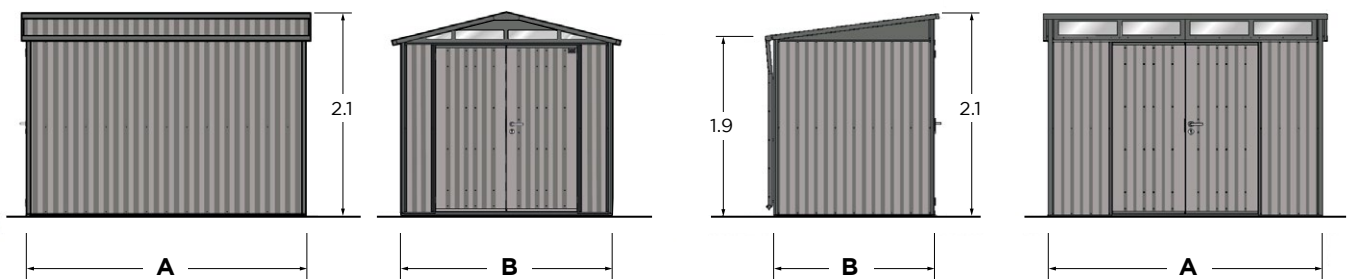

Overall Shed External Dimensions (m)

